

narbutas

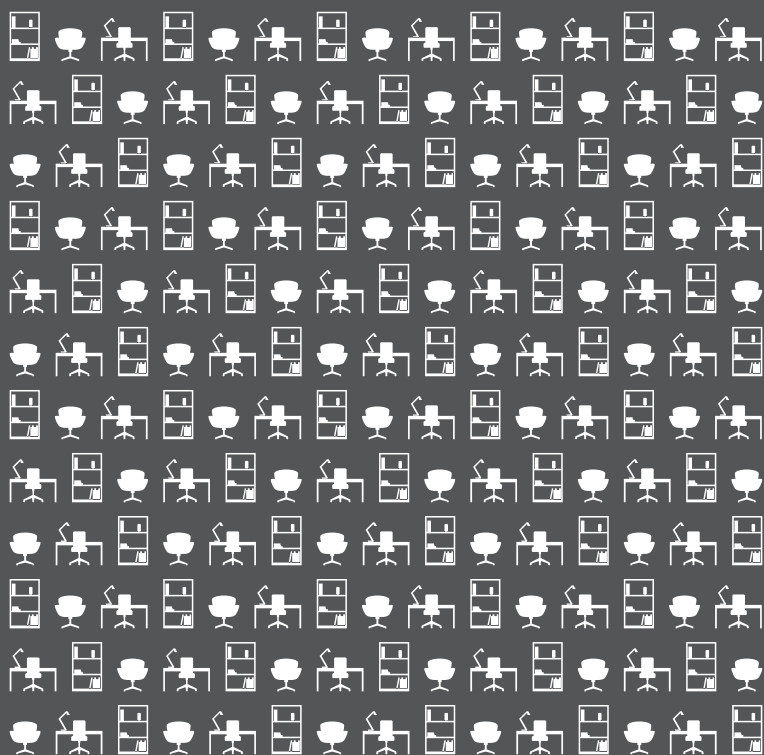

5 **Electric height adjustable desks**
Bureaux électriques réglables en hauteur | Elektrisch verstellbare Büroschreibtische



15 **Desks**
Bureaux | Büroschreibtische



35 **Acoustic screens**
Panneaux-écrans acoustiques | Akustiktrennwände

41 **Acoustic furniture**
Meubles acoustiques | Akustikmöbel

Acoustic panels
Panneaux acoustiques | Akustikplatten



49 **Cabinets**
Armoires de bureau | Büroschränke

Towers
Caissons hauts | Apothekenschränke

Pedestals
Caissons | Bürocontainer



63 **Meeting tables**
Tables de réunion | Besprechungstische

High tables
Tables hautes | Stehtische

Conference tables
Tables de conference | Besprechungstische



73 **Executive furniture**
Mobilier de direction | Chefmöbel

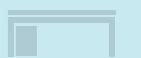

83 **Reception furniture**
Mobilier d'accueil | Empfangsmöbel

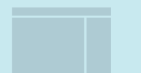



Electric height adjustable desks

Bureaux électriques réglables en hauteur | Elektrisch verstellbare Büroschreibtische

Jazz

Easy

One



Jazz

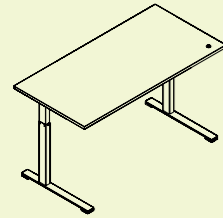
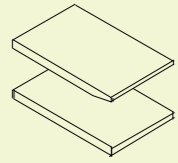

1400x800x710-1210
1600x800x710-1210

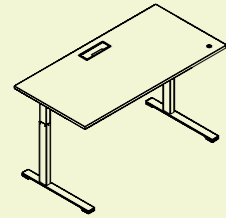

1400x800x710-1210
1600x800x710-1210

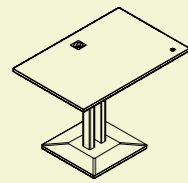

1200x800x710-1210
1400x800x710-1210

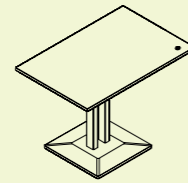

1200x800x710-1210
1400x800x710-1210

One

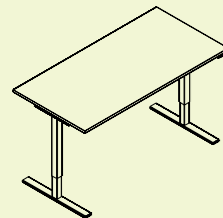
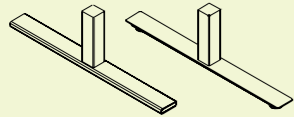

1400x800x705-1195
1600x800x705-1195

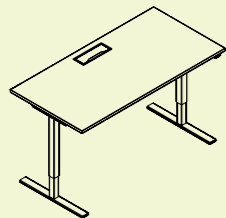

1400x800x705-1195
1600x800x705-1195

Easy

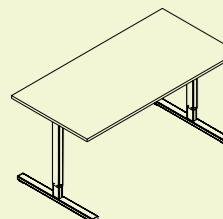
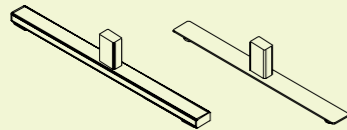

1400x800x705-1205
1600x800x705-1205

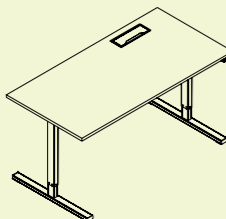

1400x800x705-1205
1600x800x705-1205

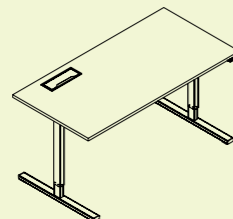

1400x800x705-1205
1600x800x705-1205

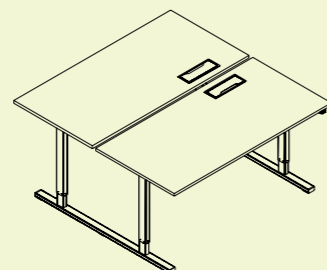

1400x1640x705-1205
1600x1640x705-1205

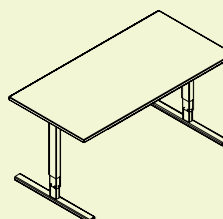

1400x800x610-1260
1600x800x610-1260

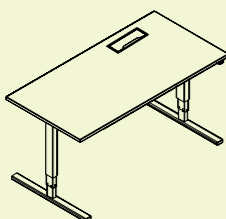

1400x800x610-1260
1600x800x610-1260

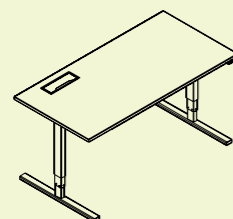

1400x800x610-1260
1600x800x610-1260

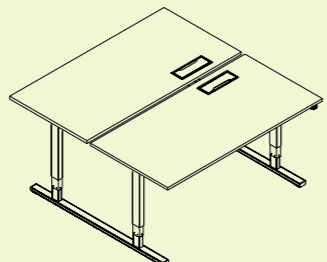

1400x1640x610-1260
1600x1640x610-1260

Jazz

design by Christina Strand and Niels Hvass



Jazz

This collection is a perfect symbiosis of free improvisation and functional solutions, with chamfered edge desks that create an extraordinary feel. Changing your position (from sitting to standing and vice versa) on Jazz height adjustable desks increases your productivity and ability to concentrate. Jazz Solo desk construction is unique in its natural concrete base.

Cette collection de meubles offre une liberté d'improvisation alliée à des solutions fonctionnelles, par ailleurs l'extrémité biseautée du plan de travail offre un excellent design. Lorsque l'on travaille sur ces bureaux il est très facile de changer de position, passant d'une position assise à une position debout, permettant une meilleure concentration et une capacité de travail accrue. Les bureaux Jazz Solo sont uniques en raison de leur base en béton.

Die Improvisationsfreiheit der Möbel dieser Kollektion harmonisiert mit funktionellen Lösungen, und die schräge Tischkante verleiht ihnen ein exquisites Design. An diesen Tischen können Sie im Sitzen oder im Stehen arbeiten und auf diese Weise konzentrierter und produktiver sein. Jazz Solo Tische stützen sich auf einen Sockel aus Naturbeton.



710 – 1210 mm



710 – 1210 mm

Jazz Solo



Easy

These are one of the most functional electric adjustable desks to maintain your concentration and productivity. Easy desks have several construction options such as different table legs, buttons and columns.

Heights: 2 column – 705-1205 mm and 3 column – 610-1260 mm.

Ce sont des bureaux extrêmement fonctionnels commandés électriquement qui améliorent le travail : augmentation de la concentration et de la productivité. Les bureaux Easy offrent différents styles de pieds de boutons.

Hauteur des bureaux : avec 2 colonnes : 705 - 1205 mm ; avec 3 colonnes : 610 - 1260 mm.

Die funktionalen Tische Easy sind elektrisch verstellbar und sorgen durch die optimierten Arbeitsbedingungen für mehr Konzentration und Produktivität. Easy-Tische sind mit unterschiedlichen Säulen und Tasten erhältlich.

Wählen Sie zwischen Tischen mit Zweifachsäulen (705-1205 mm) und Dreifachsäulen (610-1260 mm).





One

Electric adjustable desks increase your daily work efficiency. One desks have several advantages: the motor operates very silently and consumes little power. Also, you can choose from two types of table legs and add extra panels to absorb sound even better.

Ces bureaux commandés électriquement optimisent le travail au quotidien. Ils offrent des solutions optimales grâce à un mécanisme silencieux utilisant peu d'énergie. Il est possible de choisir différents styles de pieds et de fixer des panneaux-écrans acoustiques.

Elektrisch verstellbare Tische, die die positiven Auswirkungen auf die tägliche Arbeit maximieren. Auch die Tische selbst sind optimal konzipiert, denn der Mechanismus arbeitet geräuschlos und verbraucht wenig Strom. Sie können zwischen verschiedenen Tischbeinen wählen sowie schallabsorbierende Trennwände befestigen.



↑↓ 705-1195 mm





Desks

Bureaux | Büroschreibtische



Jazz

Air

Nova U

Nova U Slide

Nova U Flip-top

Nova H

Nova A

Nova O

Light

Optima C

Optima Plus

Optima G

Jazz

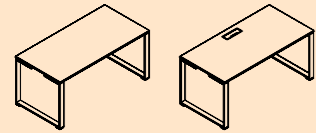

1400x800x740
1600x800x740

Air

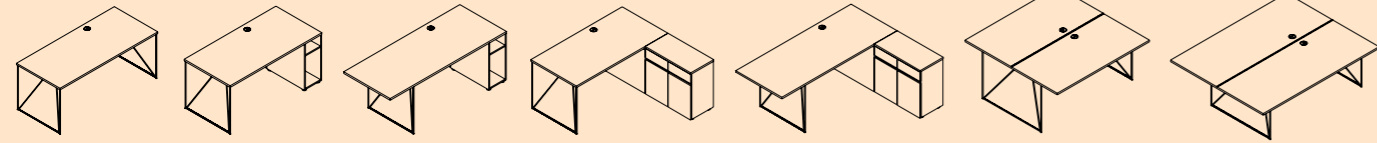

1600x800x740
1800x800x740

1600x800x740
1800x800x740

2000x800x740

1600x1600x740
1800x1600x740

2000x1600x740

1600x1600x740

2000x1600x740

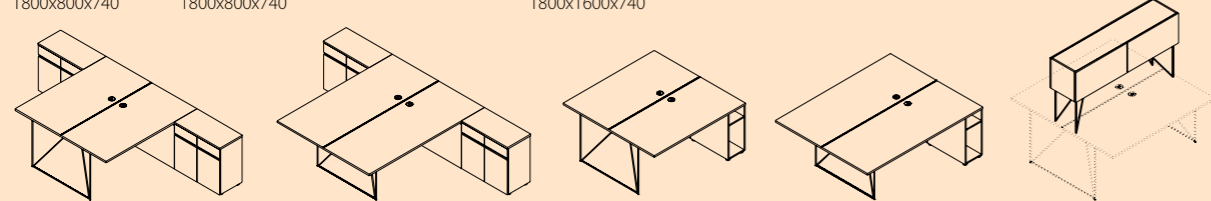

1600x3200x740

2000x3200x740

1600x1600x740

2000x1600x740

1600x400x855

Nova U

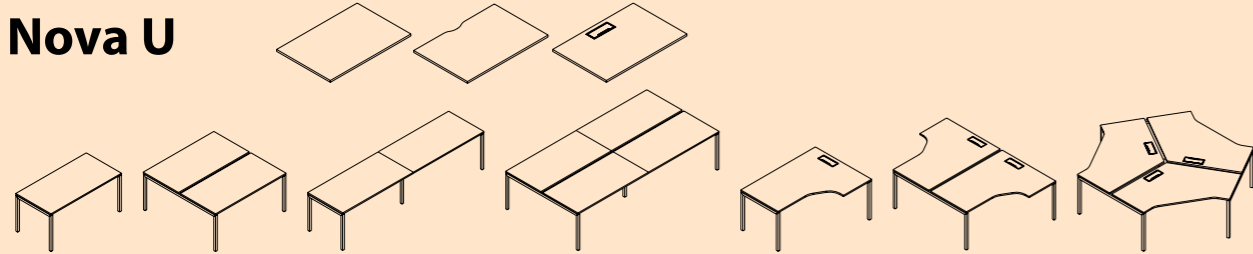

1200x600x740
1400x600x740
1200x700x740
1200x800x740
1400x700x740
1400x800x740
1600x700x740
1600x800x740
1800x700x740
1800x800x740

1200x1440x740
1200x1640x740
1400x1440x740
1400x1640x740
1600x1440x740
1600x1640x740
1800x1440x740
1800x1640x740

2400x800x740
2800x800x740
3200x800x740
3600x800x740

2400x1440x740
2400x1640x740
2800x1440x740
2800x1640x740
3200x1440x740
3200x1640x740
3600x1440x740
3600x1640x740

1400x1200x740
1600x1200x740
1800x1200x740

1400x2440x740
1600x2440x740
1800x2440x740

Ø2810x740

800x600x740
600x800x740

1440x600x740
1640x600x740

Nova U Slide

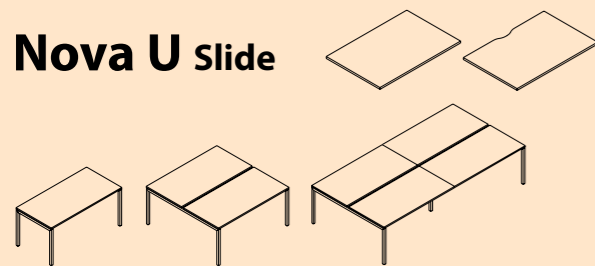

1400x700x743
1400x800x743
1600x700x743
1600x800x743

1400x1440x743
1400x1640x743
1600x1440x743
1600x1640x743

2800x1440x743
2800x1640x743
3200x1440x743
3200x1640x743

Nova U Flip-top

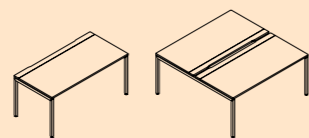

1200x800x740
1400x800x740
1600x800x740
1800x800x740

1200x1640x740
1400x1640x740
1600x1640x740
1800x1640x740

Nova A

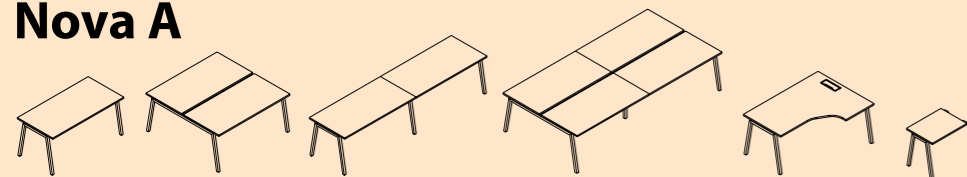

1200x600x740
1400x600x740
1200x700x740
1200x800x740
1400x700x740
1400x800x740
1600x700x740
1600x800x740
1800x700x740
1800x800x740

1200x1440x740
1200x1640x740
1400x1440x740
1400x1640x740
1600x1440x740
1600x1640x740
1800x1440x740
1800x1640x740

2400x800x740
2800x800x740
3200x800x740
3600x800x740

2400x1440x740
2400x1640x740
2800x1440x740
2800x1640x740
3200x1440x740
3200x1640x740
3600x1440x740
3600x1640x740

1400x1200x740
1600x1200x740
1800x1200x740

800x600x740

Nova H



1200x800x620-850
1400x800x620-850
1600x1200x620-850
1800x1200x620-850

Nova O

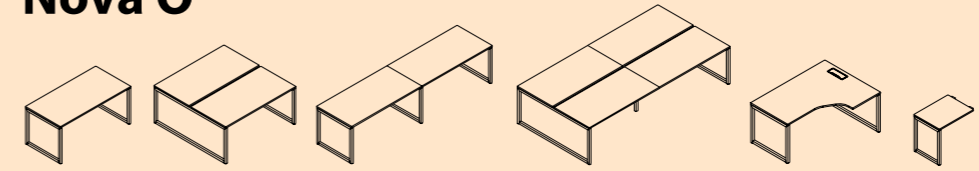

1200x600x740
1400x600x740
1200x700x740
1200x800x740
1400x700x740
1400x800x740
1600x700x740
1600x800x740
1800x700x740
1800x800x740

1200x1440x740
1200x1640x740
1400x1440x740
1400x1640x740
1600x1440x740
1600x1640x740
1800x1440x740
1800x1640x740

2400x800x740
2800x800x740
3200x800x740
3600x800x740

2400x1440x740
2400x1640x740
2800x1440x740
2800x1640x740
3200x1440x740
3200x1640x740
3600x1440x740
3600x1640x740

1400x1200x740
1600x1200x740
1800x1200x740

800x600x740

Light

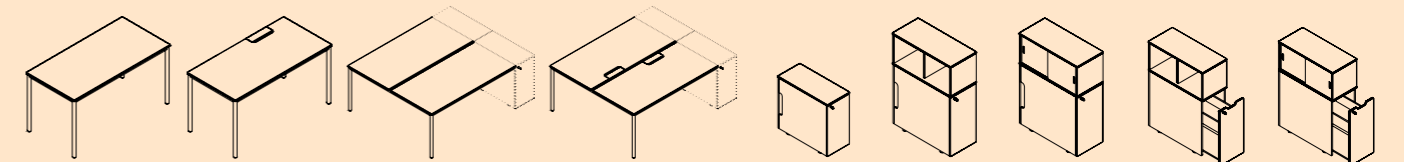

1400x700x740
1400x800x740
1600x700x740
1600x800x740

1400x700x740
1400x800x740
1600x700x740
1600x800x740

1400x1600x740
1600x1600x740

1400x1600x740
1600x1600x740

800x360x740
800x360x1090
800x360x1090
800x360x1090
800x360x1090

Optima C

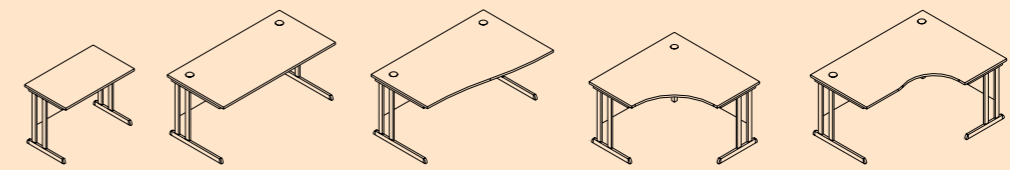

800x600x720
1000x600x720
1200x600x720

800x800x720
1000x800x720
1200x800x720
1400x800x720
1600x800x720
1800x800x720

1200x1000x720
1400x1000x720
1600x1000x720

1200x1200x720

1400x1200x720
1600x1200x720
1800x1200x720

Optima Plus

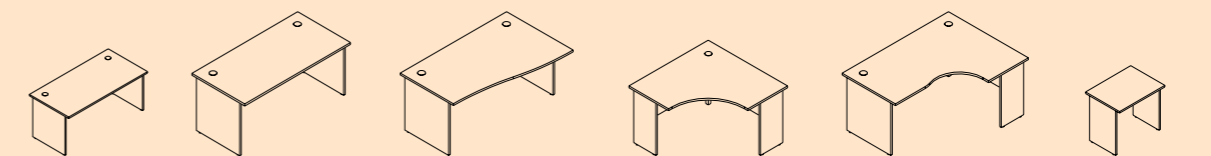

800x600x720
1000x600x720
1200x600x720

800x800x720
1000x800x720
1200x800x720
1400x800x720
1600x800x720
1800x800x720

1200x1000x720
1400x1000x720
1600x1000x720

1200x1200x720

1400x1200x720
1600x1200x720
1800x1200x720

800x600x720
1000x600x720
1200x600x720

Optima G

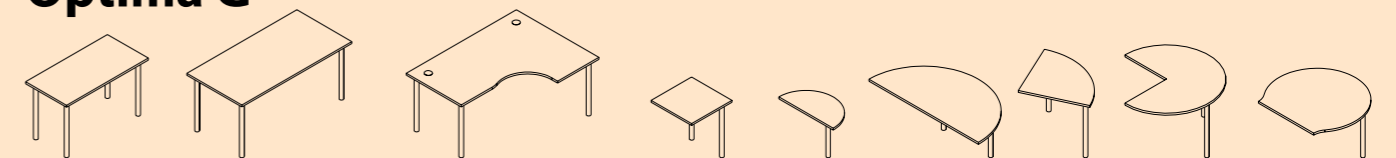

1200x600x720

800x800x720
1200x700x720
1200x800x720
1400x700x720
1400x800x720
1600x700x720
1600x800x720
1800x800x720

1400x1200x720
1600x1200x720
1800x1200x720

600x600x720
800x600x720
1200x600x720

Ø400x720
Ø800x720
Ø800x720
Ø800x720
Ø600x720
Ø1000x720



Jazz

design by Christina Strand and Niels Hvass

It is characterized by progressive structural design that creates an exclusively unique style.

Caractérisé par la conception d'une structure simple et innovante, ce qui crée un style unique.

Die Stärke von Jazz ist das einfache, dabei fortschrittliche Design, das einen einzigartigen Stil generiert.





Air

design by Gediminas Juška

It is a perfect combination of lightness and functionality. To keep your workspace clean and uncluttered, we have also created soft closing Air cabinets.

Air – un mélange de légèreté et de fonctionnalité. Au-dessus du bureau Air est fixé un meuble de rangement facilement accessible à la main et qui possède un mécanisme de fermeture silencieux. On peut y placer des objets en gardant ainsi un espace de travail propre et non encombré.

Die Serie Air steht für Leichtigkeit und Funktionalität. Über dem Air Arbeitstisch ist in bequemer Reichweite ein Schrank mit geräuschlosem Schließmechanismus angebracht. Hier können Sie verschiedene Dinge unterbringen, damit Ihr Arbeitsplatz immer aufgeräumt erscheint.





Nova U

It is universal desking system. A perfect combination of classic and modern: moderate minimalism, functionality and laconic lines.

Nova U – un système universel de bureaux. Mélange de classique et de moderne : minimalisme modéré, fonctionnalité, lignes épurées.

Ein besonders vielseitiges Tischsystem, in dem Klassik und Moderne harmonieren: moderater Minimalismus, Funktionalität und schnörkellose Linien.

Nova U Slide



An exclusively functional office desking system with pushed/pulled table tops for convenient wiring of all the IT cables you might need at your work space.

Nova U slide – sont des bureaux purement fonctionnels avec des plans de travail extensibles, permettant un accès aisé au bloc électrique et au câblage.

Funktionale Tische mit ausziehbarer Arbeitsplatte für schnellen Zugriff auf die verdeckte Stromversorgung und Kabelführung.



Nova U Flip-top



Desks with a lift-up part of the table top to help you manage all the wiring easier.

Bureau offrant une partie du plan de travail ouvrable permettant un câblage encore plus facile.

Tisch mit kippbarer Arbeitsplatte für bequemere Kabelführung.



Nova H

Various table leg adjustments allow you to change the table top height from 620 mm to 850 mm.

L'ajustement des pieds des tables Nova H permet d'adapter la hauteur du plan de travail de 620 mm à 850 mm.

Dank der verstellbaren Tischbeine können Sie für Ihre Arbeitsplatte Höhen zwischen 620 mm und 850 mm auswählen.



Nova A

Light, graceful and modern desking system is designed to highlight the exclusivity of your team.

Un design épuré et moderne offrant un environnement jeune et léger tout en mettant l'accent sur le caractère unique de votre équipe.

Das schlanke und moderne Design verleiht der Büroumgebung eine jugendliche Note und betont die Einzigartigkeit Ihres Teams.



Nova O



Desks with square shaped table legs create expressive geometric shapes around the office. Nova towers go well with all of the Nova line tables and are perfect for storing your files or personal belongings.

Les pieds de la table carrée ou rectangulaire créent des formes géométriques expressives de l'intérieur. Les rangements Nova peuvent être couplés avec toutes les tables du système, et sont adaptés pour les classeurs et pour tous les objets de travail ou personnels.

Regelmäßig geformte quadratische oder rechteckige Tischbeine sorgen für ausdrucksvolle geometrische Formen im Interieur. Die Nova Staukästen lassen sich mit allen Tischen des Systems kombinieren und eignen sich zum Ablegen von Ordnern oder persönlichen Gegenständen.





Light

Its modern minimalistic design is complimented best by expressive and lively colours. The main Light advantages include an extremely easy transportation and quick assembly.

Un design moderne et minimaliste combiné à des couleurs vives et expressives. Avantage exceptionnel de ces bureaux : leur transport aisé et leur montage rapide.

Modernes, minimalistisches Design mit ausdrucksstarken und lebendigen Farben. Ein besonderes Plus dieser Tische sind das leichte Transportieren und der schnelle Aufbau.





Optima C

Classical office furniture collection Optima is characterized as sustainable and everlasting. Optima C desks have C-shaped table legs, created to hide all the cable wiring.

Le système de meubles de bureau classique Optima se caractérise par son côté durable. Les tables Optima C ont des pieds en forme de C par lesquels s'effectuent les câblages.

Das klassische Büromöbelsystem Optima ist durch Stabilität und Langlebigkeit gekennzeichnet. Optima C Tischbeine die Form eines C und bieten sich für die Kabelführung an.



Optima Plus



Acoustic screens

Panneaux-écrans acoustiques | Akustiktrennwände



Top 530

Desk 760

Modus

Free Standing

Optima G



Top 530

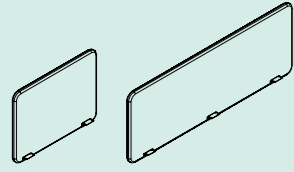

595x700x36 595x1200x36
 595x800x36 595x1400x36
 595x1600x36
 595x1800x36

Desk 760

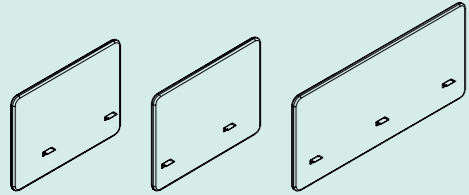

760x1000x36 760x1000x36 760x1400x36
 760x1600x36

Modus

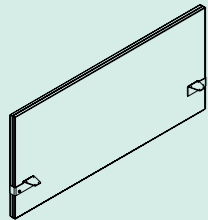

740x1400x42
 740x1600x42

Free Standing

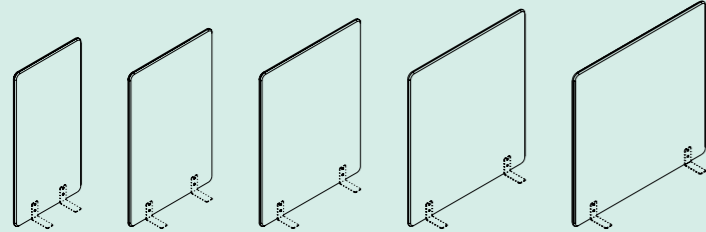

800x1200x36 1000x1200x36 1200x1200x36 1400x1200x36 1600x1200x36
 800x1400x36 1000x1400x36 1200x1400x36 1400x1400x36 1600x1400x36
 800x1600x36 1000x1600x36 1200x1600x36 1400x1600x36 1600x1600x36
 800x1800x36 1000x1800x36 1200x1800x36 1400x1800x36 1600x1800x36

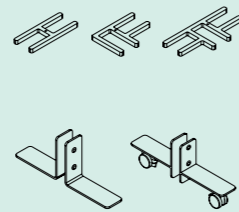

Top 530



Desk 760



Acoustic furniture is made of sound absorbing materials for reducing noise, separating workspaces and helping you to increase your concentration.

Les matériaux insonorisant utilisés dans les meubles acoustiques réduisent le bruit et décomposent les espaces, et permettent une meilleur concentration.

Akustik-Mobiliar wird aus schallabsorbierenden Materialien gefertigt, die den Geräuschpegel im Raum reduzieren und dadurch das Konzentrieren auf die Arbeit erleichtern.

Top 530

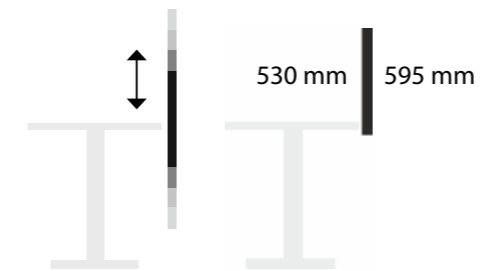

Desk 760

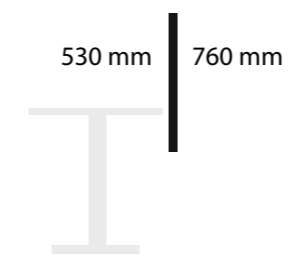

Modus

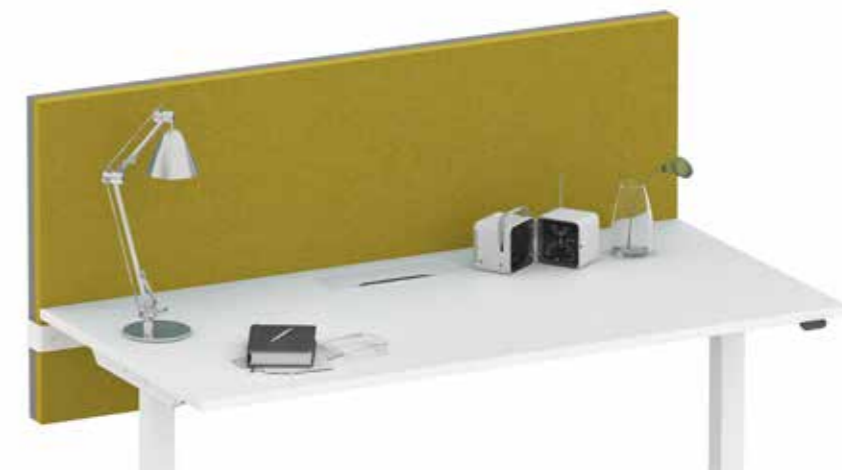
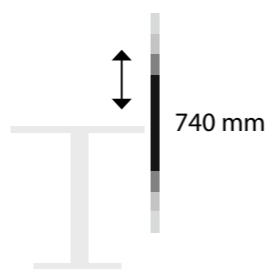

Free Standing

Sound-absorbing acoustic screens not only separate your workspace from noisy office environment, but also help you to create distinct, colorful office zones. Portable screens are easily movable all around the office.

La cloison acoustique absorbe le son environnant, elle ne protège pas seulement du bruit mais permet également de créer des zones colorées distinctes dans le bureau. Ces cloisons mobiles sont facilement maniables et intégrables dans l'espace de travail.

Die schallabsorbierende Trennwand hält nicht nur Geräusche fern, sondern bietet auch die Möglichkeit, verschiedenfarbige Zonen in Ihrem Büro zu schaffen. Die mobilen Trennwände lassen sich mühelos verschieben.



Acoustic furniture

Meubles acoustiques | Akustikmöbel

My Space

Jazz Silent Box

Acoustic panels

Panneaux acoustiques | Akustikplatten

Modus

My Space

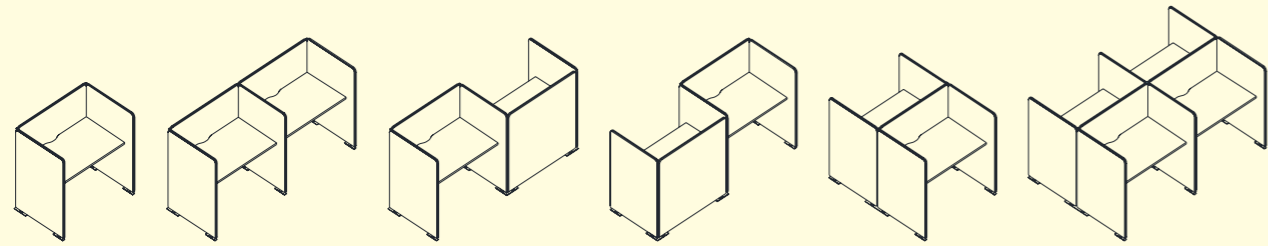

1072x1018x1270	2108x1018x1270	2108x1018x1270	2108x1018x1270	1072x2000x1270	2108x2000x1270
1272x1018x1270	2408x1018x1270	2408x1018x1270	2408x1018x1270	1272x2000x1270	2408x2000x1270
1472x1018x1270	2908x1018x1270	2908x1018x1270	2908x1018x1270	1472x2000x1270	2908x2000x1270
1672x1018x1270	3308x1018x1270	3308x1018x1270	3308x1018x1270	1672x2000x1270	3308x2000x1270

My Space Free Standing

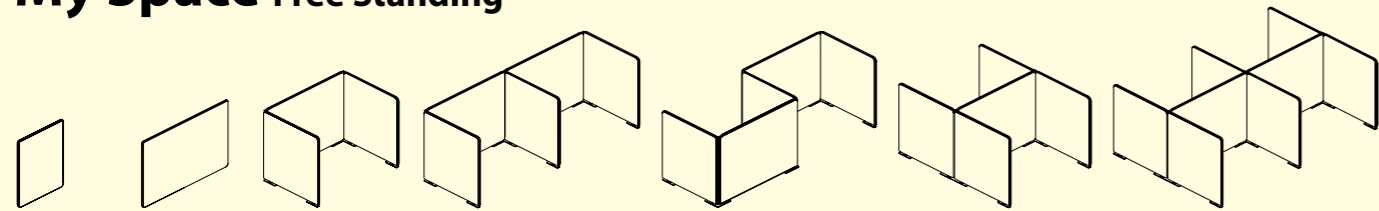

830x1237x36	1420x1237x36	1472x848x1270	2908x848x1270	2908x848x1270	1472x1660x1270	2908x1660x1270
1000x1237x36	1620x1237x36	1472x1018x1270	2908x1018x1270	2908x1018x1270	1472x2000x1270	2908x2000x1270
		1672x848x1270	3308x848x1270	3308x848x1270	1672x1660x1270	3308x1660x1270
		1672x1018x1270	3308x1018x1270	3308x1018x1270	1672x2000x1270	3308x2000x1270

Jazz Silent Box

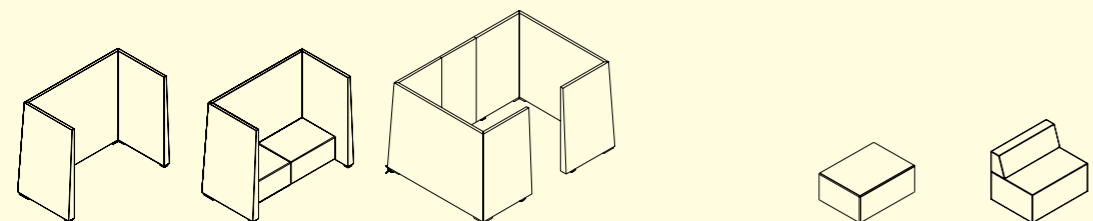

1810x925x1420	1810x925x1420	1810x2500x1420	1200x650x663	800x600x400	800x600x700
---------------	---------------	----------------	--------------	-------------	-------------

Modus

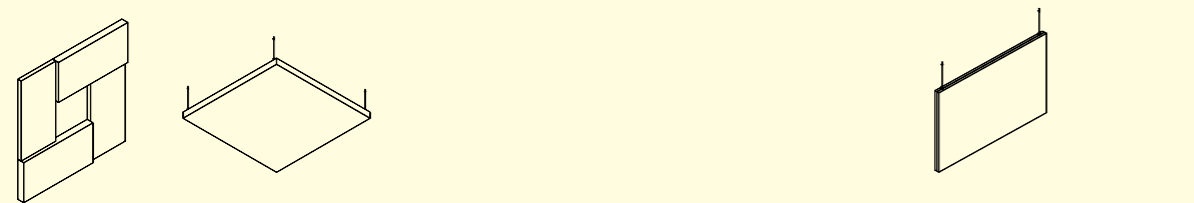

400x400x40	400x800x40	400x1200x40	800x800x40	800x1200x40	1200x1200x40	400x1200x46	800x1200x46
400x400x70	400x800x70	400x1200x70	800x800x70	800x1200x70	1200x1200x70		



My Space

My Space perfectly absorbs unwanted sounds and divides your office into personal workspaces. You can choose from My Space with either a built-in desktop or only a screen that matches your current table.

Les mobiliers acoustiques permettent simultanément : d'absorber les sons ainsi que de diviser les espaces de travail. Vous pouvez choisir My Space avec plan de travail déjà intégré ou uniquement la cloison adaptée à votre bureau existant.

Das vielseitige Akustikmöbelsystem My Space wirkt schalldämpfend und teilt zugleich den Arbeitsraum. Die Variante My Space verfügt über bereits montierten Arbeitsplatten, aber Sie können auch eine einzelne Trennwand erhalten, um Sie an den vorhandenen Arbeitstisch anzufügen.

My Space Free Standing





Modus

Acoustic panels are a modern way to reduce noise at the office. It absorbs sound, divides spaces and fulfills interior.

Les panneaux acoustiques sont une façon moderne de réduire le bruit dans un bureau. Ils absorbent les sons, divisent l'espace et remplissent l'intérieur.

Akustikpaneele – die moderne Art und Weise den Rausch zu reduzieren. Mit diesem Akustiksystem kann man den Schall absorbieren, Räume teilen und als optisch ansprechendes Design-Element den Innenraum ergänzen.



Jazz Silent Box

It is a peaceful zone at your noisy office environment. Jazz Silent Box is perfect for individual work or for taking breaks during the day.

Une zone de silence dans votre espace de travail. Espace pour un travail individuel ou pour les loisirs.

Die Ruhezone in Ihrer Arbeitsumgebung. Für individuelles Arbeiten, aber auch zum Ausruhen.



Cabinets

Armoires de bureau | Büroschränke

Light

Nova Basic

Nova Line

Uni

Uni Plus

Uni Slide

Jazz

Towers

Caissons hauts | Apothekenschränke

Jazz

Light

Nova

Pedestals

Caissons | Bürocontainer

Nova

Optima

Jazz

Air

Light

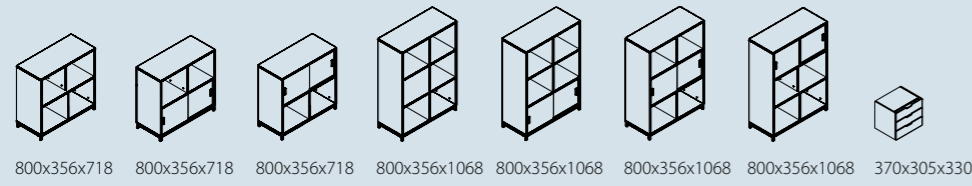

Nova Line

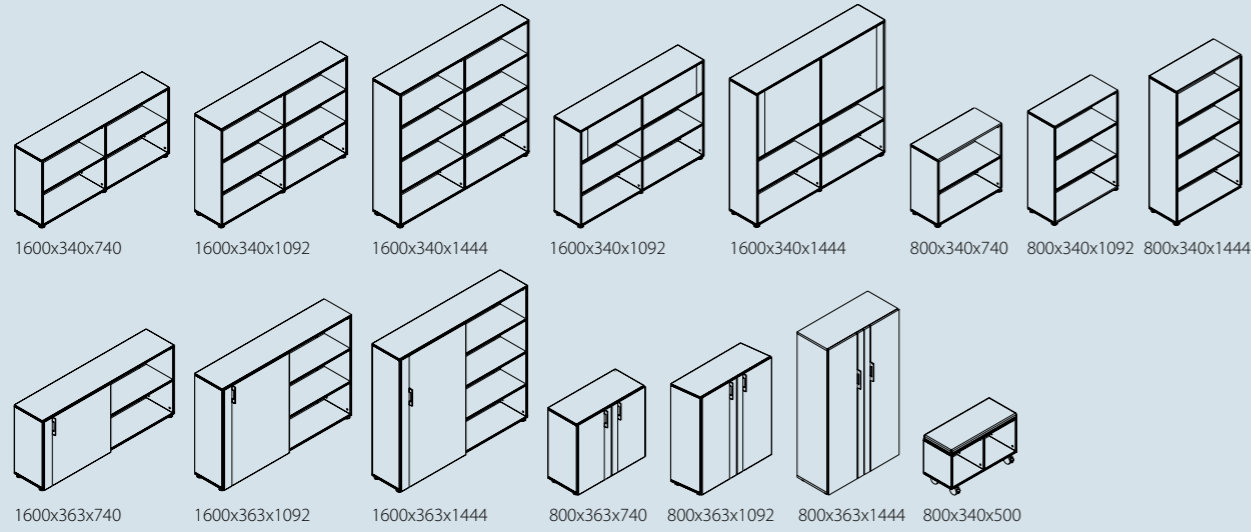

Nova Basic

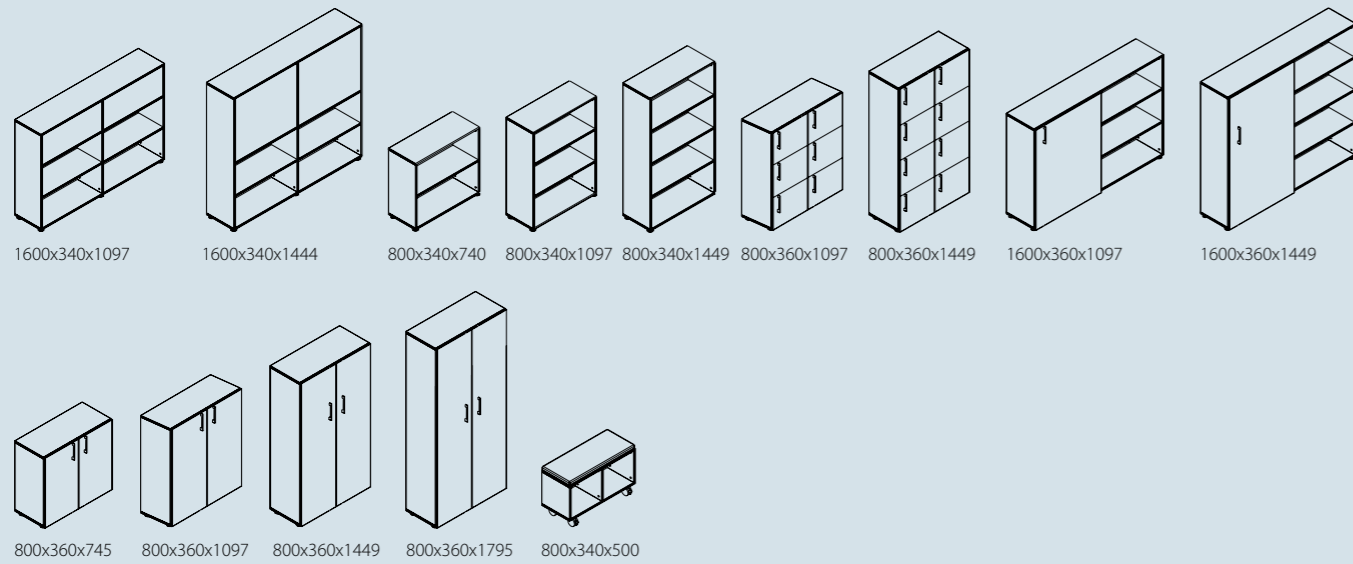

Nova Basic desk storage

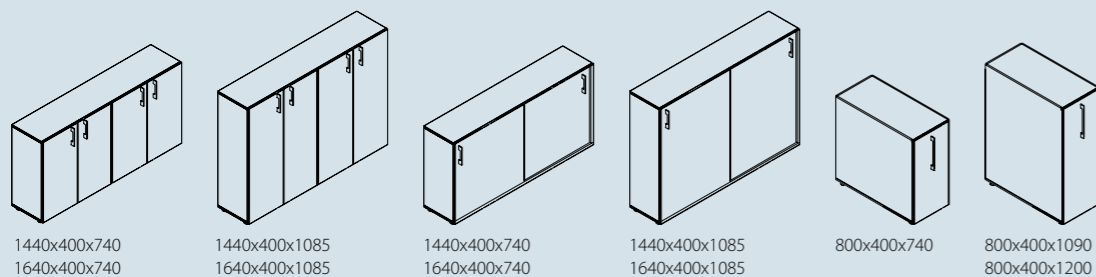

Uni

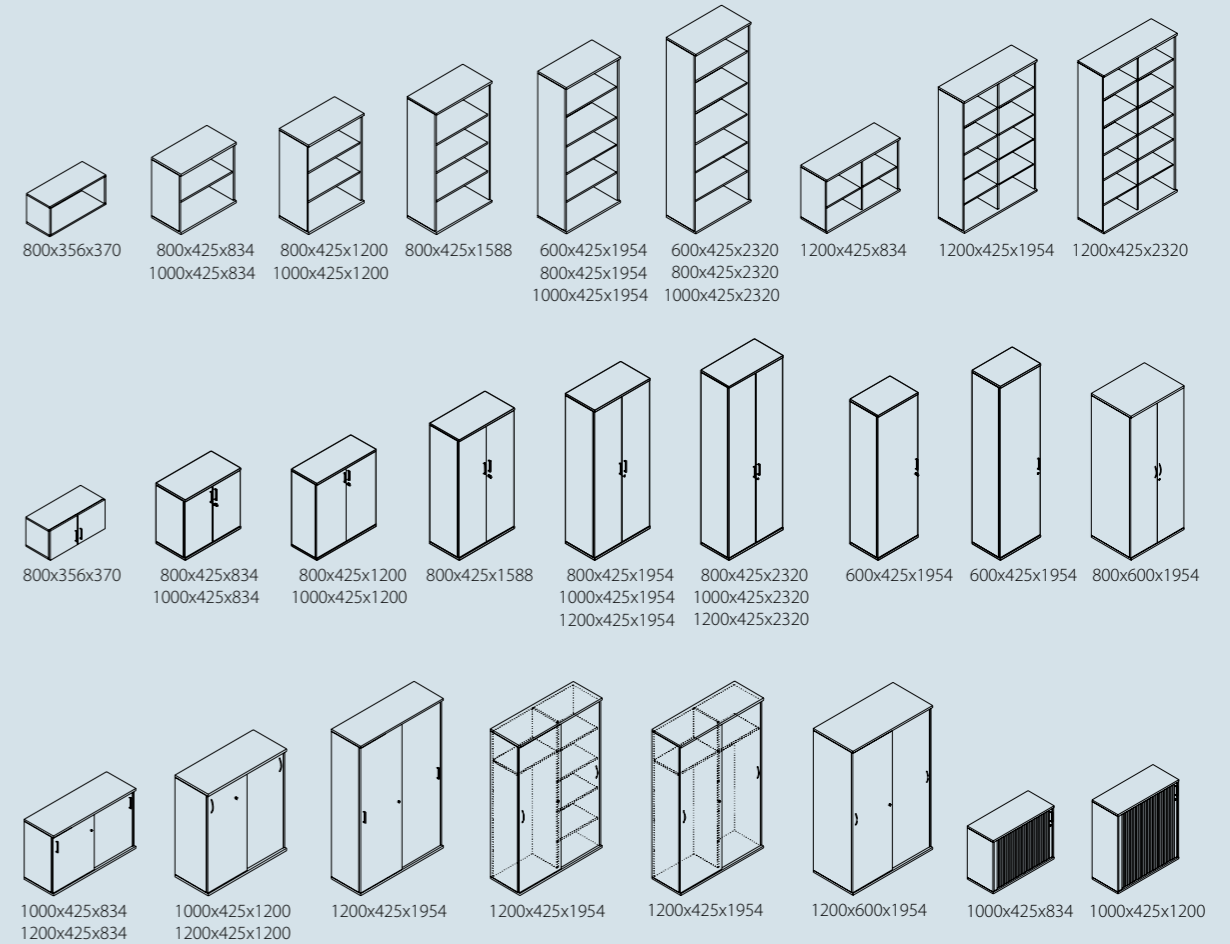
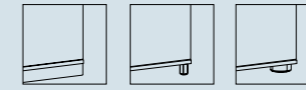

Uni Plus

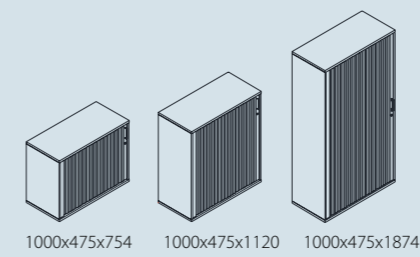

Uni Slide

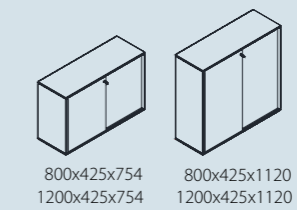

Jazz

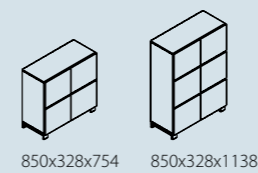

Light

This is a storage system that allows you to create your cabinet by choosing from many different colourful doors and drawers. There is always a possibility to choose different fabric colours for cabinet backs.

Système universel d'armoires de rangement. Permet de créer individuellement des combinaisons de portes et de tiroirs multi-couleurs. Il est possible de choisir des dos en tissus de différentes couleurs.

Ein vielseitiges Schranksystem, mit dem Sie Türen und verschiedenfarbige Schubladen nach eigenen Vorstellungen kombinieren können. Auch die Rückverkleidungen gibt es in verschiedenen Farben.



Nova Line

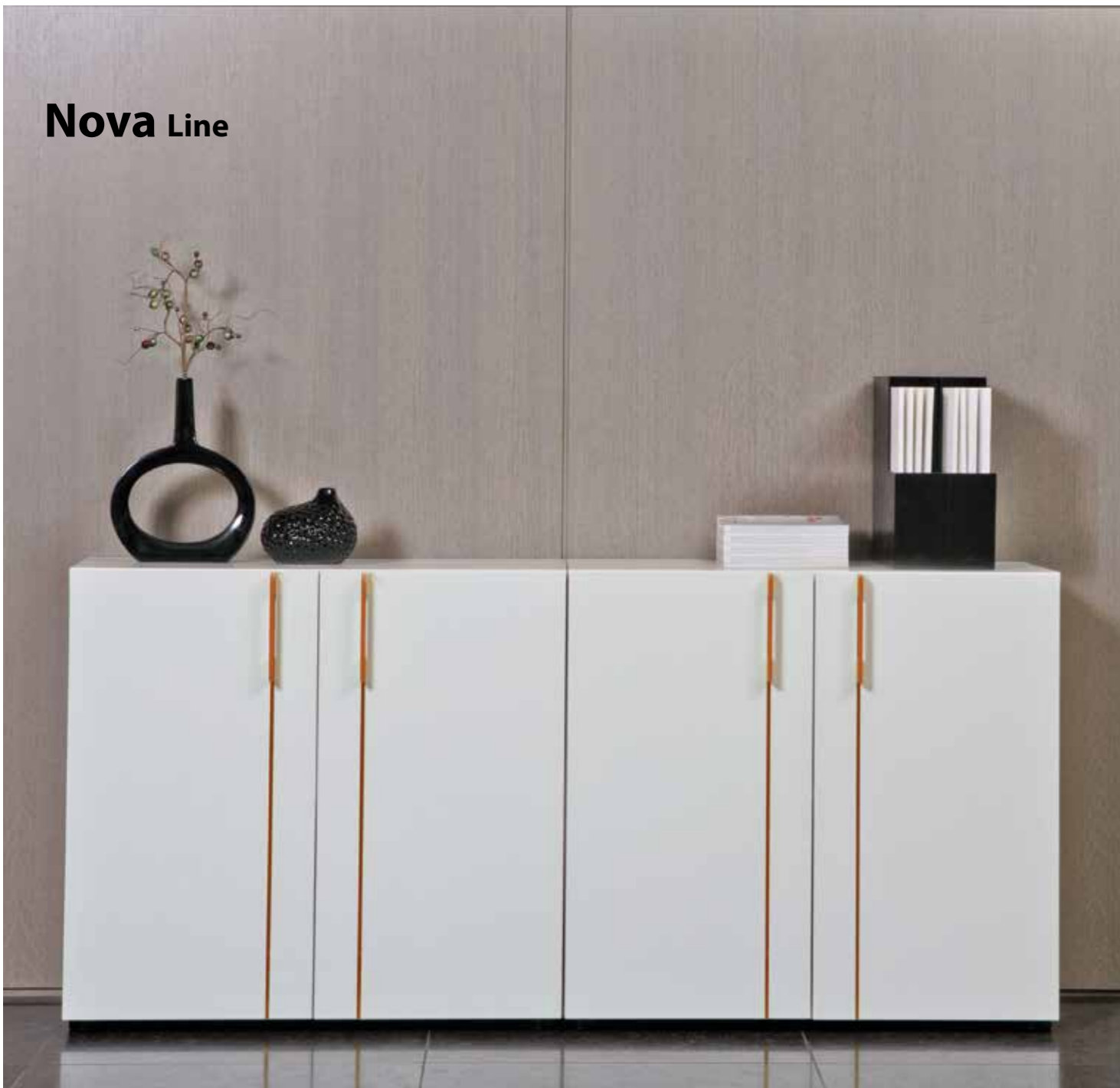

Original cabinets, decorated with plexiglas inserts and handles. Nova Line shelves and cabinets of different heights and widths (yet again, the depth is the same) will perfectly match any of our office furniture systems.

Armoires originales, décorées avec des inserts en plexiglas et des poignées. Les étagères et les armoires peuvent être de différentes hauteurs et largeurs, pour une même profondeur et s'accordent bien avec tout système de meubles de bureaux.

Schränke mit Einsätzen und Griffen aus organischem Plexiglas. Mit den offenen Regalen einheitlicher Tiefe in verschiedenen Höhen und Breiten sowie den geschlossenen Schränken lassen sie sich gut mit verschiedensten Bürosystemen kombinieren.



Nova Basic



Practical and functional high-capacity shelves and cabinets of different heights and widths (yet the depth is the same) can be easily combined in work environments to create various comfortable individual work areas.

Armoires de rangement fonctionnelles et de grande capacité, de différentes hauteurs et largeurs pour des profondeurs égales; étagères ouvertes ou armoires fermées, afin de créer des zones de travail communes ou individuelles.

Funktionelle und geräumige offene Regale einheitlicher Tiefe in verschiedenen Höhen und Breiten sowie geschlossene Schränke für gemeinsame und individuelle Arbeitsbereiche.





Uni

This exclusively wide range of cabinets allows you to choose from shelves of different heights, depths and widths, paired with different types of possible cabinet doors. Backs of the cabinets may be covered in whiteboard or in fabric for sound absorption.

Caractérisées par une large palette d'armoires permettant de choisir parmi des étagères de différentes hauteurs, largeurs et profondeurs avec différents types de portes. Le dos peut être recouvert de tapisseries absorbant le bruit, ou de tableaux blancs pour écrire.

Ein besonders breites Schranksystem, das die Wahl zwischen Regalen verschiedener Höhen, Breiten und tiefen sowie verschiedenen Arten von Türen bietet. Die Rückenwand kann mit schallabsorbierendem Stoff verkleidet oder einer weißen Schreibtafel ausgestattet werden.



Uni Plus

Cabinets with tambour doors and shelves with special built-in dividers (file drawers) are suitable for convenient storing of documents.

Armoire à rideaux avec étagères et séparateurs tiroirs classeurs pour un archivage aisé de documents.

In diesem Schrank mit Lamellentüren und vielen einzelnen Registern lassen sich hervorragend Dokumente archivieren.



Cabinet shelves with dividers for documents, fixed or retractable metal frame.

A l'intérieure de l'armoire, étagères avec les diviseurs pour les documents, avec ou sans cadre en métal intégré.

Die einzelnen Registern können Sie auch zum Herausnehmen mit metallenen Rahmen erhalten.



Uni Slide

Cabinets with sliding doors. These capacious cabinets are made to store your work equipment and personal items.

Armoires de bureau avec des portes coulissantes. Ces armoires spacieuses sont faites pour y ranger votre matériel de travail et vos affaires personnelles.

Schränke mit sanftes Öffnen der Schiebetüren. In diesen räumigen Schränken können Sie Ihre Arbeitsmittel und persönliche Artikel aufbewahren.

Jazz

design by Christina Strand and Niels Hvass

Geometric shapes and perfectly straight lines create a sense of coherence.

Design aux formes géométriques, lignes droites apportant un sentiment d'harmonie.

Geometrische Formen und gerade Linien vereinen sich zu einem harmonischen Gesamtbild.



Jazz



800x380x1156



800x400x740



800x400x1200



800x400x1090

Nova



800x360x740



800x360x1090



800x360x1090



800x360x1090



800x360x1090

Light

Nova



DNF632
428x600x560
|2|4|

DNF633
298x600x560
|2|4|

DNF626
428x600x560
|2|4|7|

DNF627
298x600x560
|2|4|7|

DNF642
430x600x740
|2|4|

DNF636
430x600x740
|2|4|7|

DNF422
428x600x410
|2|4|

Optima



PSR540
415x500x638
|1|10|

PSR541
415x500x638
|1|4|10|

PSR535
415x500x638
|1|4|7|10|

PSR532
415x500x510
|1|4|10|

PSR525
415x500x510
|1|4|7|10|

PUR636
430x600x600
|2|4|9|

PUR642
430x600x600
|2|4|5|8|9|

PUR637
430x600x672
|2|4|7|9|



PSS642
415x600x720
|1|4|9|

PSS637
415x600x720
|1|4|7|9|

PUS642
415x600x720
|2|4|8|9|

PUS635
430x600x720
|2|4|6|9|

PUS835
415x800x720
|2|4|6|8|9|

PSS837
415x800x720
|1|4|7|9|



PEX627
500x600x720
|1|4|7|8|9|

PEX637
500x600x1020
|1|4|7|8|9|

PEX647
500x600x1320
|1|4|7|8|9|

PSP525
415x500x446
|1|4|7|

PSP532
415x500x446
|1|4|7|

Jazz



DGF630
294x600x590
|1|4|7|8|

DGF620
294x600x590
|1|4|7|8|

Air



DIF430
436x600x520
|1|4|

DIF431
436x600x520
|1|3|4|

- | 1 | Foil wrapped drawers
- | 2 | Metal-sided drawers
- | 3 | Silent closing mechanism
- | 4 | Central locking
- | 5 | First pencil drawer
- | 6 | File drawer
- | 7 | Full extension file drawer suitable for A4 or foolscap filing
- | 8 | Anti-tilt mechanism
- | 9 | Top 25 mm
- | 10 | Top 16 mm

- | 1 | Tiroirs avec côtés MDF
- | 2 | Tiroirs côtés métalliques
- | 3 | Mécanisme de fermeture silencieux
- | 4 | Fermeture principale
- | 5 | Tiroir pour accessoires de bureau
- | 6 | Tiroir pour classeurs suspendus
- | 7 | Tiroir pour classeurs suspendus à extension totale
- | 8 | Mécanisme « Anti-tilt »
- | 9 | Dessus 25 mm
- | 10 | Dessus 16 mm

- | 1 | Schubladen mit MDP-Seiten
- | 2 | Schubladen mit Metallseiten
- | 3 | Soft close
- | 4 | Zentralverriegelung
- | 5 | Schublade für Schreibutensilien
- | 6 | Schublade mit Hängeregistern
- | 7 | Bis zum Anschlag herauszieh bare Schublade mit Hängeregistern
- | 8 | „Anti-Tilt“-Mechanismus
- | 9 | Deckel 25 mm
- | 10 | Deckel 16 mm

Meeting tables

Tables de réunion | Besprechungstische



Nova

Forum

T-Easy

Air

Jazz

Hight tables

Tables hautes | Stehtische

Jazz

Nova

Light

Conference tables

Tables de conference | Besprechungstische

Flip-top

Nova

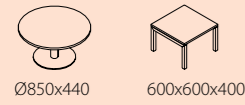
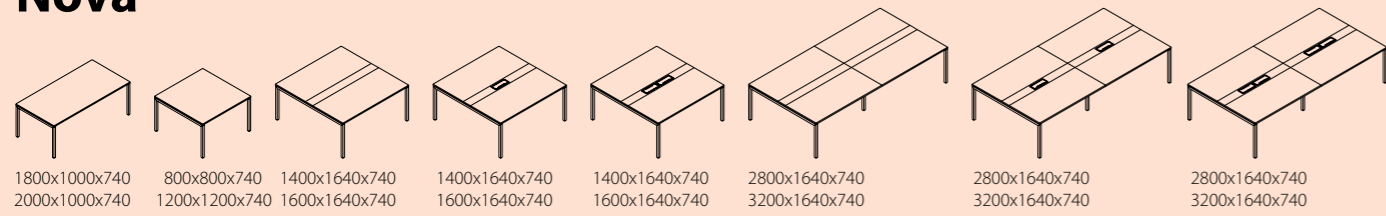

Forum

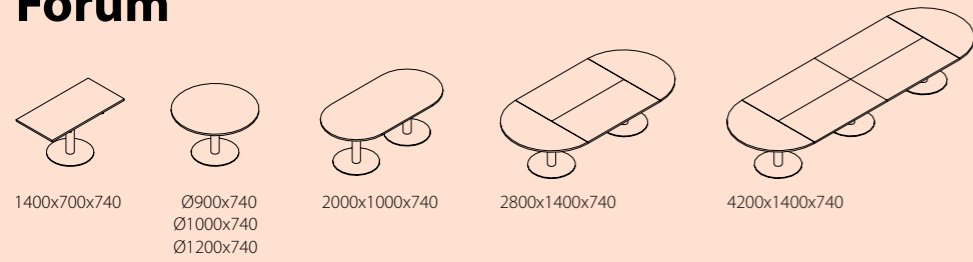

T-Easy

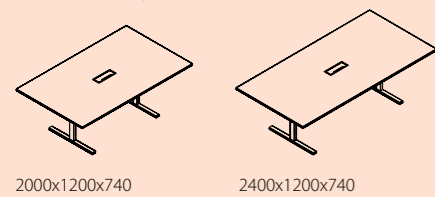

Air

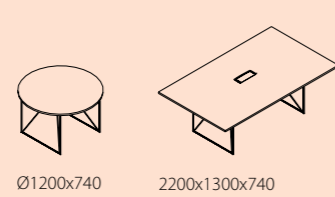

Jazz

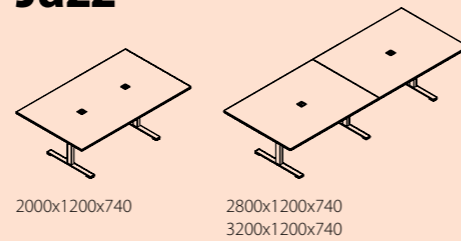

Jazz

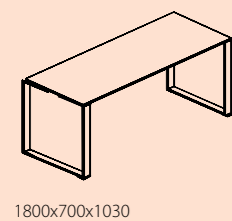

Nova



Light

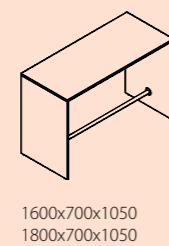

Flip-top



Tables of various sizes and shapes: rectangular or round, providing more comfort and productivity for your meetings. IT equipment wiring and power sockets are mounted under the table top.

De différentes tailles et formes : rectangulaires ou rondes, apportant intimité et confort pour les réunions. Des blocs spéciaux sous le plan de travail permettent de cacher les boîtes d'électricité et le câblage.

Verschiedene Größen und Formen - rechteckig oder rund – sorgen für eine familiäre Atmosphäre. Unter den Arbeitsplatten befinden sich Fächer für Stromversorgung und Kabel.





Forum

Characterized as universal, Forum tables have only one table leg in the center, so the number of people sitting around is not limited. If particular changes need to be made, various table compounds can be created as well.

Aspect universel : tables ovales avec pied central ne limitant ainsi pas le nombre de personnes assises et permettant suivant l'évolution des besoins de combiner avec d'autres tables.

Diese vielseitigen Tische werden von einer einzigen Säule in der Mitte getragen und bieten daher Platz für nahezu unbegrenzt viele Sitzplätze. Wenn sich der Verwendungszweck ändert, können Sie auch die Tische neu kombinieren.



T-Easy

T-Easy stands for neutral aesthetic design. It perfectly blends into an existing working space and contributes to overall office interior. Goes well with Easy height adjustable tables.

Conception esthétique neutre. Ces tables s'intègrent parfaitement à un espace de travail existant. Complètent parfaitement les tables Easy.

Neutrales, ästhetisches Design, das sich hervorragend in jeden Arbeitsraum einfügt und ihn ergänzt. Wir empfehlen die Kombination mit höhenverstellbaren Easy Tischen.

Air

design by Gediminas Juška



Air design provides an outstanding feel of comfort and openness. These tables are made for comfortable communication.

Leur conception offre un confort et la sensation d'un espace ouvert. Ces tables sont créées pour une communication agréable.

Ein Design, das für Behaglichkeit sorgt und dem Raum zugleich Weite verleiht – für Konferenzen wie geschaffen.



Jazz

design by Christina Strand and Niels Hvass

Fixed height and precisely shaped meeting tables are created for teams of eight, ten or twelve people.

Tables de réunion de hauteur fixe, de formes précises et de différentes tailles : pour une équipe de huit, dix ou douze personnes.

Die klar und exakt geformten Konferenztische einheitlicher Höhe gibt es für acht, zehn und zwölf Personen.

Jazz

design by Christina Strand and Niels Hvass



Nova

Designed for leisure and quick meetings, high table Nova with U-shaped legs goes in perfect harmony with Nova furniture collection.

Les tables hautes Nova dont les pieds sont en forme de U sont destinées à des zones de repos ou pour des courtes réunions. Elles complètent harmonieusement le système des meubles Nova.

Für Ruhebereiche oder kurze Besprechungen eignen sich der Stehtische Nova mit U-förmigen Beinen, die sich hervorragend in das Nova-Möbelsystem einfügen.



Light

High table Light with flat table legs. Laconic style and design solutions go perfectly well with many different interiors.

Tables hautes Light avec pieds panneaux. Leur forme épurée et leur conception permettent de les combiner avec différents types de solutions intérieures.

Die Stehtische Light mit Paneelbeinen passen sich dank schlichter Form und Konstruktion mühelos an verschiedenste Interieurs an.





Executive furniture

Mobilier de direction | Chefmöbel



Plana

Air

Nova

Zeta

Era

Flip-top

Flip-top design allows you easily to change the table top position from horizontal to vertical. These tables are highly compact and easy to store.

Tables avec plan de travail rabattable : pouvant facilement passer d'une position horizontale à une position verticale. Elles peuvent donc être rangées ou stockées verticalement sans prendre beaucoup d'espace.

Die Arbeitsplatte können Sie horizontal oder vertikal kippen. Diese Tische lassen sich gut lagern und nehmen wenig Platz ein.



Plana

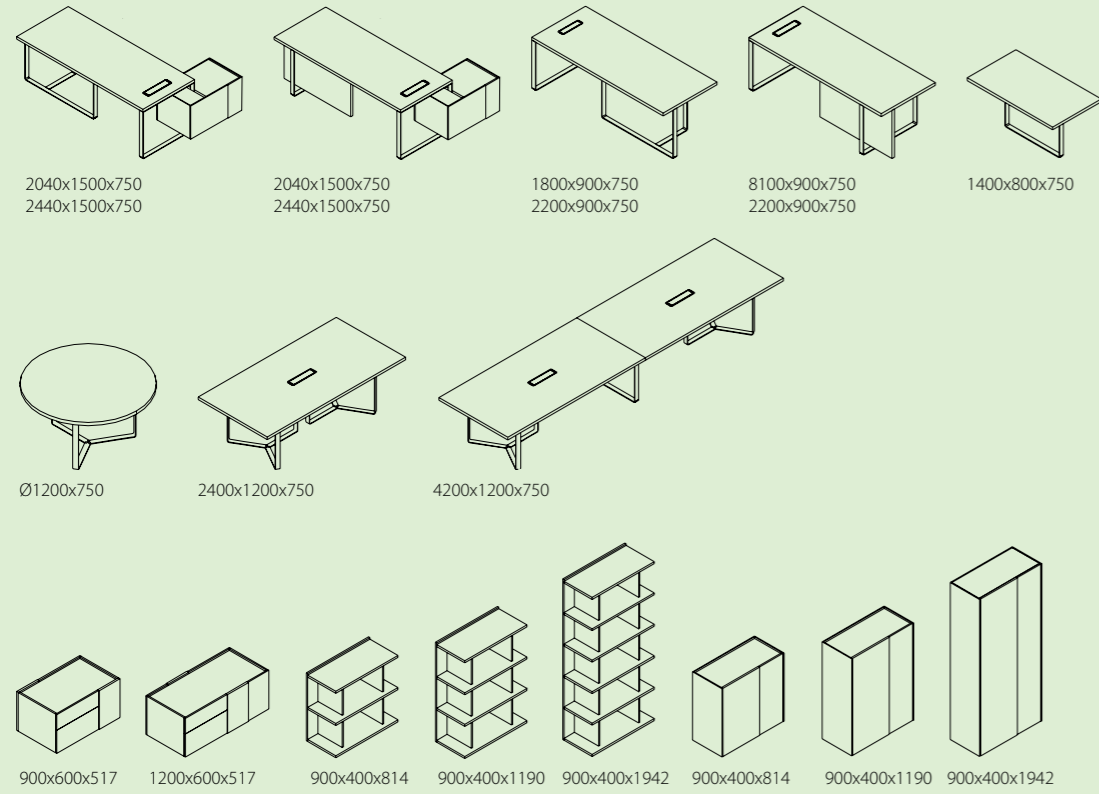

Air

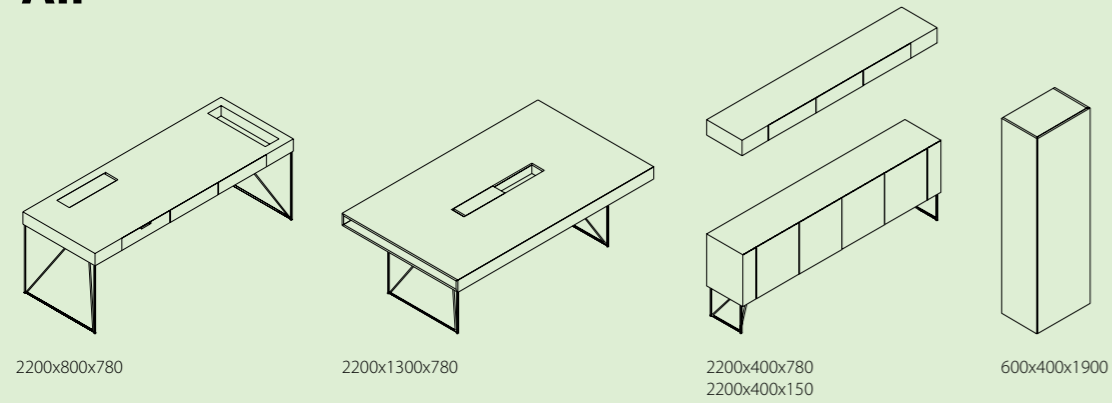

Nova

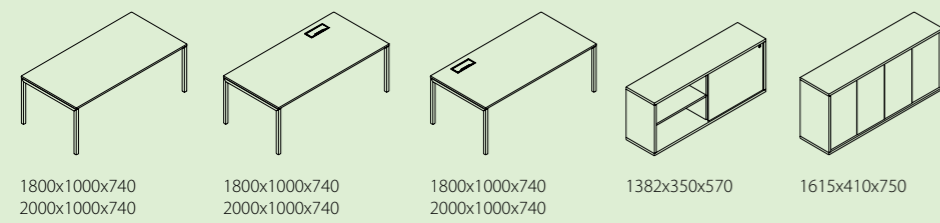

Zeta

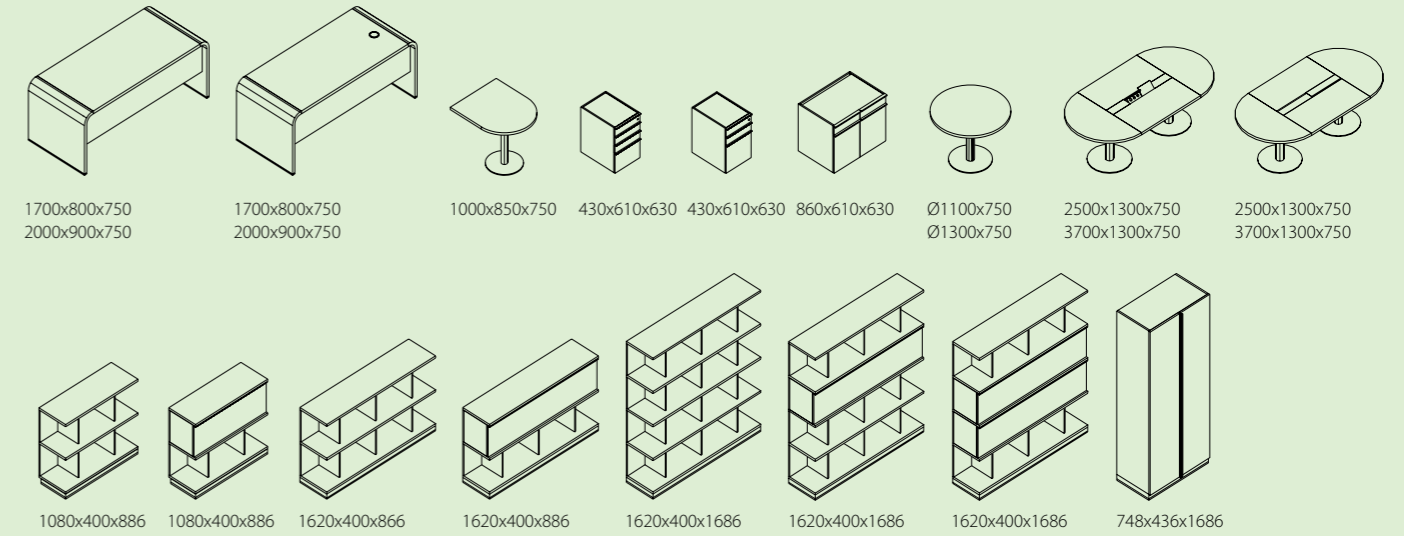

Era

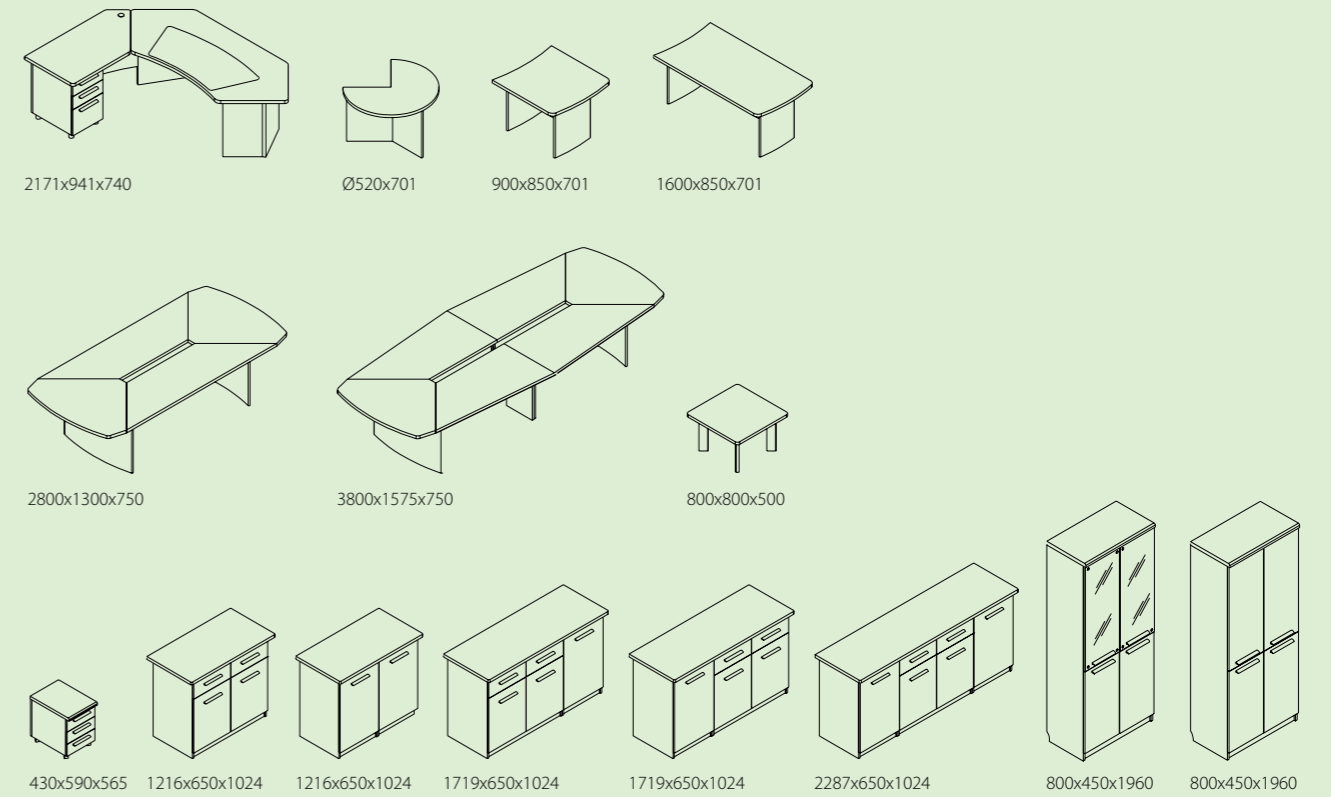

Plana

design by Roberto Lucci & Paolo Pampanoni



It is a modern high-quality furniture collection. Straight lines, smooth-running forms, warm, refined materials. Aesthetics and functionality create a sense of luxury.

Collection de meubles modernes et de haute qualité. Des lignes droites, des formes régulières, différentes épaisseurs, utilisation de matériaux raffinés. Solution pour une conception esthétique et fonctionnelle offrant un sentiment de luxe.

Eine moderne, besonders hochwertige Möbelkollektion. Gerade Linien, gleichmäßige Formen, unterschiedliche Stärken und warme, raffinierte Materialien. Das ebenso geschmackvolle wie funktionelle Design verströmt einen Hauch von Luxus.

Air

design by Gediminas Juška

The perfect combination of aesthetics and functionality. The essential part of Air Executive is its natural wood veneer table top and steel legs that ensure not only the elegant feel of the table, but also its stability and solidity. Steel table legs are designed in a way so you could easily hide all the cable wiring and keep all the unnecessary items out of your main workspace.

Mélange offrant esthétique et fonctionnalité. Le plan de travail massif, en bois naturel, semble en sustentation dans l'air sur des pieds effilés en acier chromé. Les câbles Internet et électriques peuvent s'y faufiler offrant un bureau de responsable toujours propre.

Ästhetisch und funktional. Die massive, naturholzbeschichtete Arbeitsplatte auf den schlanken verchromten Stahlbeinen erscheint wie in der Luft schwebend. Die Beine eignen sich für Kabelführung und sorgen dafür, dass auf dem Tisch des Chefs stets Ordnung herrscht.





Nova

Moderate minimalism and laconic lines. This collection is designed for democratic and modern executives, who appreciate the quality of the details and functionality in the work environment.

Minimaliste modéré, lignes épurées. Ceci est un mobilier conçu pour un chef moderne et à l'écoute, attentif aux détails, à la qualité et à la fonctionnalité de l'environnement de travail.

Verhaltener Minimalismus und schnörkellose Linien – die idealen Möbel für einen integrativen und modernen Chef, der hochwertige Details und Funktionalität in seiner Arbeitsumgebung zu schätzen weiß.



Zeta

design by Vaidas Zabulionis

Expressive yet solid. Sleek table forms and open shelves together create a comforting feeling of space and mindfulness.

Expressif et solide. La forme aérodynamique de la table et des étagères ouvertes donne une agréable sensation de confort invitant à des réflexions et des idées nouvelles.

Massiv und eindrucksvoll. Die fließenden Formen des Schreibtisches und die offenen Regale geben dem Raum Weite, in der die Ideen ungehindert fließen können.



Era

design by Jurgita Liubartaitė



Modern functionality and classic come together. Massive table top with natural mahogany covering and leather inlay imparts luxury and solidity.

Mélange de classique et de la fonctionnalité moderne. Le plan de travail massif en acajou naturel et en marqueterie de cuir offre aux meubles une solidité et un luxe exclusif.

Hier kommen Klassik und Moderne zusammen. Die massive Arbeitsplatte mit natürlicher Mahagoniholzbeschichtung und einem Einsatz aus Naturleder verleiht den Möbeln Luxus und Seriosität.

Reception furniture

Mobilier d'accueil | Empfangsmöbel

Cosy

Ice

Nova

Tera

Salve

Cosy

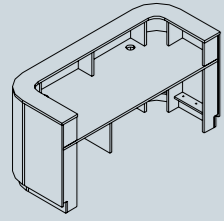

2000x800x1025

Ice

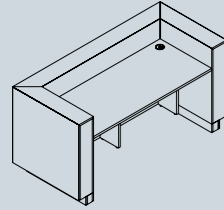

2000x900x1000

Nova

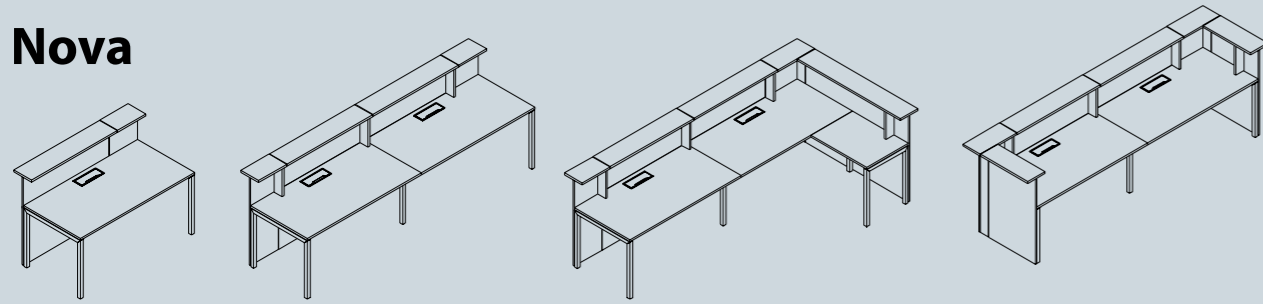

1600x935x1125
1800x935x1125

3200x935x1125

3340x1735x1125

3470x935x1125

Tera

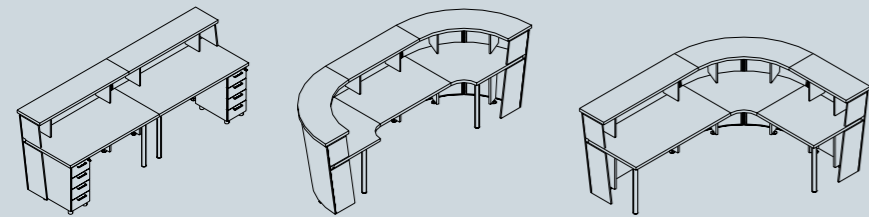

3000x893x1115

3350x1100x1115

2600x2000x1115

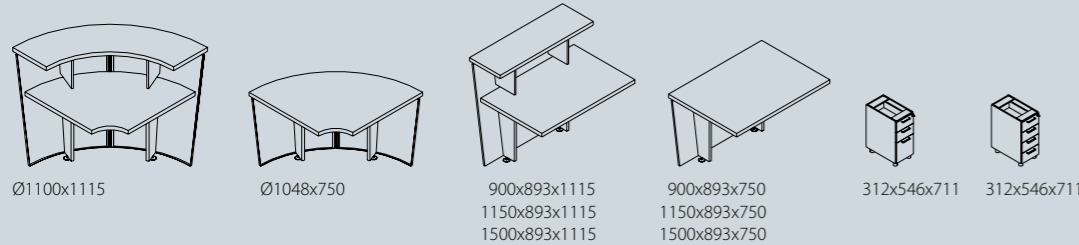

Ø1100x1115

Ø1048x750

900x893x1115
1150x893x1115
1500x893x1115

900x893x750
1150x893x750
1500x893x750

312x546x711

312x546x711

Salve

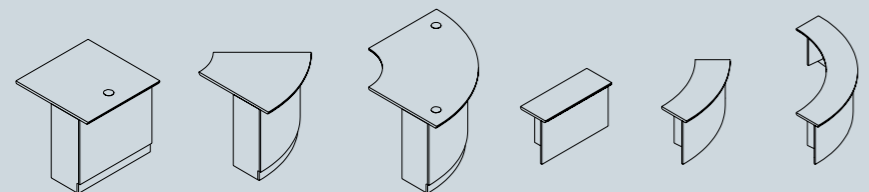

800x800x735
1200x800x735

Ø1195x735

Ø1195x735

800x300x400
1200x300x400

Ø1275x400

Ø1275x400



Cosy



Ice

design by Kristina Zuokienė

Light, minimalist and purely geometric design. Precisely white and glossy Ice reception furniture attracts the eye and leaves a great first impression.

Léger et minimaliste, design aux formes géométriques propres. D'un blanc brillant et pur, les meubles d'accueil Ice créent l'impression d'exclusivité.

Leichtes, minimalistisches Design mit streng geometrischen Formen. Die strahlend weißen Empfangsmöbel Ice verleihen Ihren Büroräumen den gebührenden Glanz.



Nova

Delight in its simplicity, Nova reception furniture stands out with its exclusive decor detail – plexiglas inserts that compliment your office interior with a more elegant and unique feel.

Mobilier d'accueil qui fascine par sa simplicité et ses détails de décoration exclusifs : les inserts en plexiglas créent un intérieur de bureau élégant et unique.

Durch Einfachheit bestechendes Empfangsmobiliar mit exquisiten Dekor. Die Plexiglas-Einsätze lassen Ihre Büroräume besonders stilvoll erscheinen.



Tera

design by Vaidas Zabulionis

Stylish and elegant. By selecting different coatings and colors, you can create the perfect reception interior: moderate and minimalist or cozy and harmonious.

Élégant et raffiné. Possibilité de choisir différents revêtements et couleurs pour créer un accueil au style que l'on désire : sobre et minimaliste ou confortable et harmonieux.

Stilvoll und elegant. Wählen Sie verschiedene Bedeckungen und Farben, um Ihrem Empfangszimmer den gewünschten Stil zu geben: verhalten minimalistisch oder eher gemütlich.



Salve

design by Henrikas Sabaliauskas

Strict geometric shapes team up with round, wavy shapes of the Salve reception table to create the ultimate comfort feel.

Les ormes géométriques strictes mais également circulaires et ondulées apportent du confort au bureau.

Streng geometrische und runde Formen erzeugen eine gemütliche Büroatmosphäre.

Melamine | Mélamine | Melamin

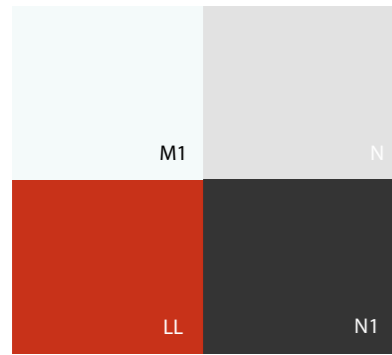

Melamine | Mélamine | Melamin



- D1 Whitened Oak | Chêne blanchi | Eiche gebleicht
- U Walnut | Noyer | Walnuss
- P Birch | Bouleau | Birken
- T Beech | Hêtre | Buche

HPL | HPL | HPL

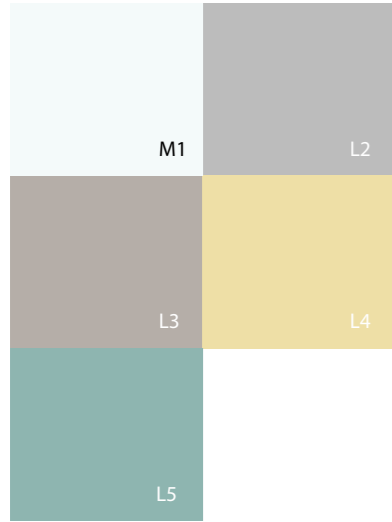

Veneer | Placage | Furnier



- A Oak | Chêne | Eiche
- F Mahogany | Acajou teinté | Mahagoni
- V Cherry | Merisier | Kirsche
- K Maple | Érable | Ahorn
- R Walnut | Noyer | Walnuss
- G Wenge | Wengé | Wenge

Plexiglas (perspex) | Plexiglas | Plexiglas

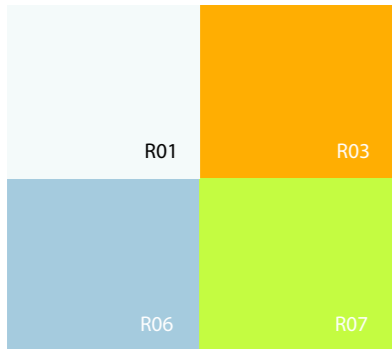

Metal | Pieces métalliques | Metall

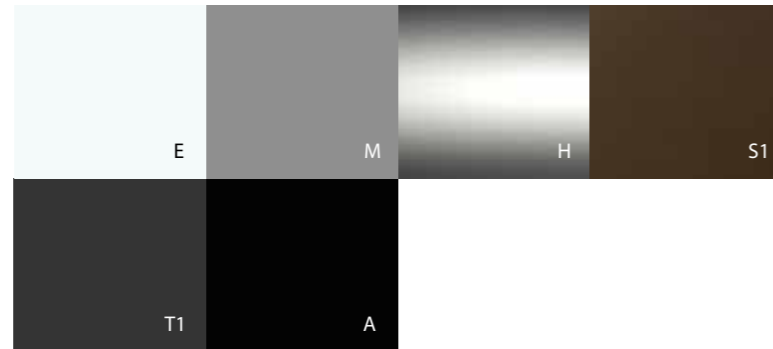

Velito Presto (88% wool, 12% polyamide)

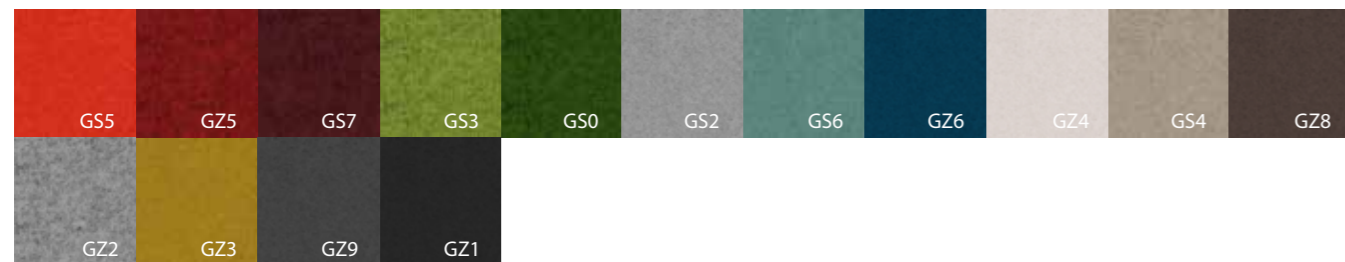

Lucia (100% recycled polyester)



narbutas

Narbutas Furniture Company, UAB | Phone: +370 5 2107 922 | Šeškinės str. 55A, LT-07159 Vilnius, Lithuania | www.narbutas.com